

ape[®]
Active Playground Equipment



Proposal for:
TVDSB – Plattsville & District PS

Play made easy!

Proposal and Quotation

To: Danielle Kettle

Please find enclosed Active Playground Equipment's proposal for your yard at Plattsville & District PS.

At Active Playground Equipment, we strive to not only meet, but to exceed all of your expectations and requirements. We would be more than happy to modify this proposal in any area that you may require.

Active Playground Equipment has been providing quality playgrounds to municipalities, schools, and childcare centers for over 26 years. Our personal service, detailed designs, and willingness to provide multiple revisions, all add up to 100 percent customer satisfaction upon completion of all of our projects.

Thank you in advance for your time and consideration.

Kind Regards

Vielka Macias

Contents

Proposal Details and Costing	3
Important Notes	3
General Terms & Conditions	4
Acceptance of Proposal & Quotation	4
Natural Product Specifications	5
Engineered Wood Fiber Specifications	6
Structure Specifications	7
Statement of Warranty & CSA Compliance	9
Colour Options	11

Proposal Details and Costing

Customer Information

Thames Valley District School Board
 Danielle Kettle
 (519) 452-2444 ext. 21035
 d.kettle@tvdsb.ca

Installation Location

Plattsville & District Public School
 112 Mill St. E.
 Plattsville, ON
 N0J 1S0

Quotation Date: December 12, 2021.

NAT-000011 SENSORY TABLE 22" (2)	\$ 2,258.00
NAT-000030 WEAVE PANEL FREESTANDING LARGE (1)	\$ 1,289.00
NAT-000048 LOG TABLE & CHAIRS	\$ 1,320.00
Install Kits	\$ 400.00

Delivery and Installation Option \$ 5,281.35

- *Mobilization of APE installation crew with all tools and equipment required to install the above component(s) using a combination of custom stringers and poured concrete footings.*
- *Clean up and return site to preconstruction condition.*

Engineered Wood Fiber Safety Surface Material \$ 5,606.64

- *Includes: Approx. 9" Engineered Wood Fiber; Geo Textile Filter Cloth; Approx. 3" Drainage Gravel; Two layers of 6x6 ACQ Retaining Wall. No cap.*
- *5 YEAR LIMITED WARRANTY (Details Below)*

Subtotal \$ 16,154.99

Taxes Not Included

Important Notes

**** Area calculated based on 400 Sq Ft. ****

General Terms & Conditions

- All prices are in Canadian funds.
- A 25% deposit may be required with your purchase order.
- Balance of payment is Net 30 Days subject to credit approval.
- If paying by credit card, a 3% surcharge is applied.
- Requests for tax exemption must include supporting documents.
- This Quotation is firm for a period of 14 days. After 14 days Active Playground reserves the right to adjust pricing unless an extension is agreed to in writing.
- FOB Point Edward Ontario unless stated otherwise.
- The Quotation is based on shipment of all items at one time to a single destination unless stated otherwise.
- Availability is approximately 6-8 weeks after receipt of your Purchase Order, deposit, and confirmation of colour choices where necessary.
- Installation is subject to inclement weather including but not limited to rain, snow, high winds, below grade frost and/or low temperatures. Some unitary surfacing can only be installed within a specific temperature range to ensure proper curing. Active Playground reserves the right to change installation dates, if necessary, to meet health and safety concerns for installation crews and/or installation specifications of materials used.

Acceptance of Proposal & Quotation

I hereby accept this Proposal & Quotation subject to the terms and conditions and authorized Active Playground to proceed with the order.

Signature

Name (Please Print)

Date

Purchase Order Number

Natural Product Specifications

Lumber is a living element; as such, changes to the wood's appearance and surface are to be expected. When exposed to the extreme elements of Canadian weather patterns, both wooden logs and ACQ lumber will expand and/or contract. Expansion and contraction of timber can lead to small cracks, weathering, and even slight splintering. Whether traditional or natural, all playground equipment requires ongoing maintenance to ensure the longevity and safety of the piece is

preserved. In the event of cracks or splintering, sanding down rough patches with a fine grain sandpaper or re-sealing the wood may be required. Full maintenance details are provided in the Active Playground maintenance guide upon delivery/installation.

Cracks, splinters, or weathering of natural pieces is expected and adds to an authentic natural experience. As pieces acclimatize to their new surroundings you may notice

cracking within hours of installation. In most cases, these natural processes do not compromise the structural integrity of the piece and simply add to the aesthetic appeal of natural products. If safety is a concern, Active will request photos of the weathering for assessment. With proper ongoing maintenance, children can enjoy their natural play spaces for many years to come.



Engineered Wood Fiber Specifications

It is a truly Canadian, engineered, impact surface, composed of specially processed wood grindings, complimented by a unique, high performance drainage layer which provides playground owner/operators with a cost effective, low maintenance and impact absorbing surface for children to play on.

Engineered Wood Fiber provides superior impact attenuation performance available with thickness geared to fall heights. It has been tested by CSA and

exceeds all of the requirements of the CAN/CSA- Z614- 14 Standard for Children’s Play Spaces and equipment.

Engineered Wood Fiber mats together to form a consistent surface which allows barrier free access for wheelchairs, strollers, and walkers. This product has been tested by Detroit Testing Laboratories to be compliant with the A.S.T.M. F1951 Standard for Playground Surface Accessibility.

Engineered Wood Fiber is priced below other accessible surfaces

and combined with its low maintenance cost, is one of the lowest cost surfaces on the market.

Engineered Wood Fiber installs easily. You may choose to do-it-yourself or have your system installed by Active Playground Equipment. We can also provide various types of retaining wall systems.

The natural wood look will enhance the aesthetic value of your play area and will not find its way into your children’s clothing or you’re building like sand or pea gravel.



Structure Specifications

A. Materials

Steel Components

All steel tube components are manufactured by Allied Tube & Conduit and incorporates their Flo-Coat™ galvanizing system. This includes a three-layer exterior coating comprised of zinc galvanizing, chromate conversion and clear organic. The interior is treated with 90% zinc coating.

Railings

Top and bottom rails are 1 3/8" (34.93mm) diameter complete with 1" (25.4mm) diameter spindles.

Post Caps

Cast aluminum caps with 3/16" (5mm) minimum thickness friction fit to top of posts.

Decks

Composite structure consisting of angle and 11 gauge (3.12mm) expanded metal plate complete with structural reinforcements. Standard deck dimensions: 48" (1220mm) x 48" (1220mm) x 2" (50mm). All decks are perforated with 7/8" (22mm) diameter (finished size) holes. Platforms with the larger holes typically remain clean and clear of debris (a CSA standard) and offer the least amount of opportunity for injury.

Posts

All vertical posts are 5" (127mm) diameter x 13 gauge (1.8mm) in accordance with ASTM 569.

Rotationally Molded Plastic Components

Rotationally-molded plastic parts are molded from linear medium-density polyethylene resin. All parts are solid in colour and include U.V. stabilizers. All parts have an average wall thickness ranging from 0.125" (3.18mm) to 0.375" (9.53mm).

Play Panels

High-density polyethylene compression molded panels 3/4" (199mm) thick. With U.V. stabilizers and antic static protection.

Fasteners

All fasteners are 316 grade stainless steel.

B. Finishes

Powder Coating

All steel components (excluding decks) are powder coated. Metal preparation for powder coat finish consists of sandblasting to eliminate micro-rust and scale and profile the steel to maximize powder adhesion. Parts are then

cleaned and pre-baked to eliminate any liquid residue and prepare for coating.

Polyester dry powder coating is electrostatically applied, and oven cured at 400°F (204°C) resulting in a surfacing thickness of 3-5 mil (0.076mm – 0.127mm) that is extremely durable.

Plastisol Coating

Plastisol coating is a polyvinyl chloride with an average thickness of 0.15" (3.81mm).

Prior to coating, parts are chemically washed, epoxy primed, and allowed to dry completely. Parts are pre-heated to 350°F (177°C) and submerged in Plastisol. Plastisol contains a flame-retardant additive and U.V. stabilizer to maintain colour, and fungastat to improve resistance to fungal growth.

Statement of Warranty & CSA Compliance

All Parts and Labour Inclusive

Active Playground Equipment Inc. (ACTIVE) warrants that if any of our playground components fail due to defects in workmanship or materials we will repair or replace all parts found defective without cost provided that the initial installation was, and subsequent repair is completed by authorized ACTIVE installers.

ACTIVE additionally warrants against structural failure due to corrosion and/or deterioration caused by defects in materials and workmanship as follows:

Steel Support Posts	Lifetime Warranty
Stainless Steel Hardware	Lifetime Warranty
All Other Metal Components	20 Years
Plastic (HDPE & Rotational Molded) Components	10 Years
Cables	5 Years
Shade Fabric	1 Year
Moving Parts	3 Years
Electronic Components	1 Year
Coating Delamination:	
Armor Coat (Electrostatically Applied Polyester)	5 Years
Cushion Guard (PVC "Plastisol")	5 Years
CSA (ASTM) Compliance Guarantee	1 Year
Dimensional ACQ Lumber	3 Years
Raw Lumber	1 Year

All plastic components will experience some natural fading and discolouration with exposure to ultraviolet light. Aggregates used as a safety surfacing and/or installed near the play equipment will reduce the normal life of all coating due to enhanced abrasion.

Lumber is a living element; as such, changes to the wood's appearance and surface are to be expected. When exposed to the extreme elements of Canadian weather patterns, both wooden logs and ACQ lumber will expand and/or contract. Expansion and contraction of timber can lead to small cracks, weathering, and even slight splintering.

ACTIVE warrants that all playground equipment products manufactured and installed by ACTIVE installers will be completed in strict accordance with CSA- Z614-07 and all subsequent addendums (ASTM F1487 where applicable). ACTIVE will rectify, without cost, any non-compliant issues caused by improper design, manufacturing, or installation procedures.

Exclusions

Warranty claims will be compromised should any claim be a result of:

- Vandalism, abuse, misuse, or accident.
- Normal cosmetic changes such as: scratches, dents, marring, fading, discolouration, cable fraying.
- Acts of God such as: hail, flooding, lightning, tornadoes, sandstorms, earthquakes, windstorms, etc.
- Environmental factors such as: windblown or human dispersed aggregates, salt spray, salt water.
- Normal wear and tear such as: Armour Coat and Cushion Guard wear in access/egress areas.
- Failure to maintain in accordance with Active Playground Equipment Inc. maintenance guide and CSA requirements.
- Improper Installation: When installed by a party other than an Active Playground Equipment Inc. authorized installer.
- Unauthorized additions, alterations, or repairs by a party other than Active Playground Equipment Inc.
- Unintentional CSA (ASTM) non-compliance oversight which was not reported within 12 months after date of invoice.
- Other regulatory requirements or inspector comments that exceed or are outside of the scope of CSA Z614 or ASTM 1487.

Conditions

Warranty period applies from date of invoice.

Third Party Products: Warranties of products that are not manufactured directly by Active Playground Equipment Inc. are limited to the original equipment manufacturer's warranty terms.

Colour Options

Steel

Panels

Plastics

Please Note: Spiral Slides are only available in the following colours: Dark Red, Dark Yellow, Green, Blue and Tan.

February 2021

NATURAL - PLAY TABLES

Sensory Table (Toddler)



- Trays easily remove for cleaning and storage
- Provides 360-degrees of play
- Available in 18" and 22" heights
- Replacement trays available
- Heavy-duty, restaurant grade trays



Available in infant and toddler height, complete with two or three sinks, the sensory table offers a perfect space to experiment with water and other playground materials. With easily removeable trays for cleaning and storage, your little scientists are free to complete messy scientific investigations. Expressive and receptive language and non-verbal communication flourish as your little Einstein's work together on their latest and greatest scientific breakthroughs.



Motor Skills

- Balance
- Coordination
- Motor Planning
- Crossing the Midline
- Hand-Eye Coordination
- Hand Arches
- Pincer Grasp



Cognitive

- Problem Solving (Logic & Reasoning)
- Focus
- Attention
- Comprehension



Social/Emotional

- Parallel, Joint or Cooperative Play
- Turn-Taking
- Sharing



Communication

- Expressive and Receptive Language
- Non-Verbal Communication (Gestures)



Sensory Processing





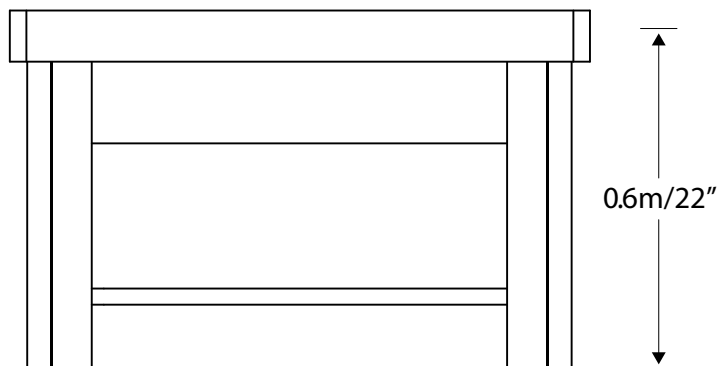
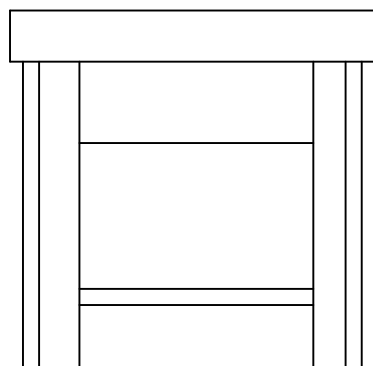
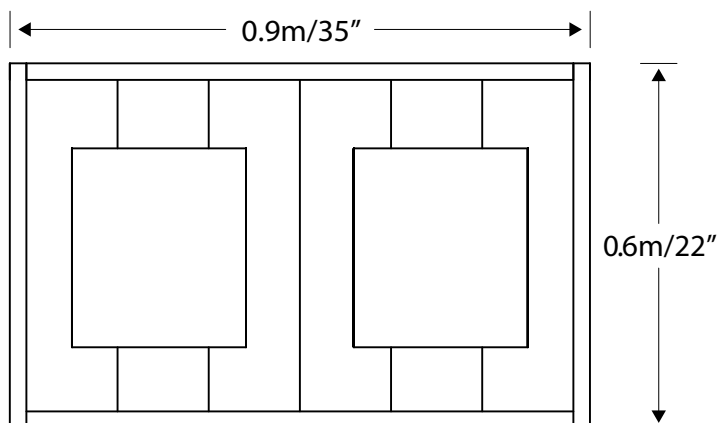

- Tactile
- Visual

Play made easy!

NATURAL - PLAY TABLES

Sensory Table (Toddler)



-  **Target Age**
18 months to 5 years
-  **Use Area**
5.99 m² / 64.50 ft²
-  **Installation Type**
Easy
-  **Est. Weight**
40 lb
-  **Safety Surfacing**
Not Required
-  **Dimensions**
0.9m x 0.6m x 0.6m
35" x 22" x 22"
-  **Materials**
 - Pressure Treated Lumber
 - Modified Lumber
 - Stainless Steel Bins

Please contact APE for a site specific plan for your playground to ensure CSA compliance and spacing requirements.

*Active Playground Equipment reserves the right to redesign, change or discontinue products without written notice. Products in our printed literature and detailed in our quotations may differ from what is available at the time an order is placed. Please check with your Active Playground representative to confirm that the product you will receive is what you are expecting. Revised January 2019.



NATURAL - PLAY PANELS

Weave Panel (Large)



- Powder-coated weave frame helps prevent rusting
- Panel can be swapped with other various APE panels (speak with your sales rep for more info)
- Can be used on both sides if space allows



Aspiring designers, and artists alike are able to polish their craft with Active Playground's weave panel. Available in small or large sizes, the weave panel features a powder-coated frame to prevent rusting and is built to meet CSA standards. Functional on both sides, weaving can also be interchanged with other APE panels: chalkboard and paint, for maximum creativity. Little designers thrive with use of the weave panel. Expect an invitation to their collection's debut in the mail any day.



Motor Skills

- Balance
- Coordination
- Crossing the Midline
- Hand-Eye Coordination
- Bilateral Coordination
- Pincer Grasp



Cognitive

- Problem Solving (Logic & Reasoning)
- Focus
- Attention
- Comprehension



Social/Emotional

- Parallel, Joint or Cooperative Play
- Turn-Taking
- Sharing



Communication

- Expressive and Receptive Language
- Non-Verbal Communication (Gestures)



Sensory Processing

- Tactile
- Visual
- Vestibular

NATURAL - PLAY PANELS

Weave Panel (Large)

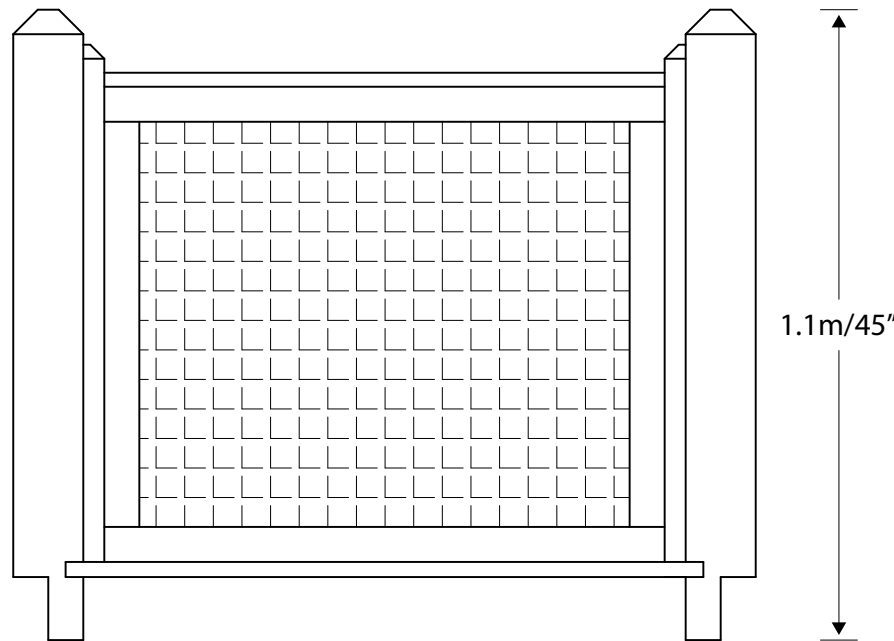
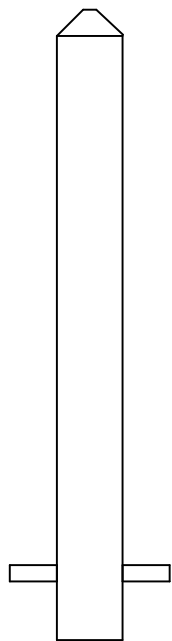
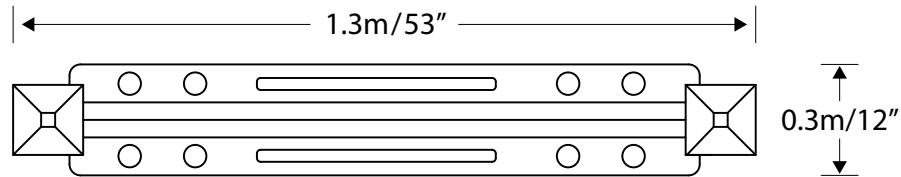

Target Age
18 months to 5 years



Use Area
6.36 m² / 68.50 ft²



Installation Type
Moderate



Est. Weight
100 lb



Safety Surfacing
Not Required



Dimensions
1.3m x 0.3m x 1.1m
53" x 12" x 45"



Materials

- Pressure Treated Lumber
- Modified Lumber
- Steel Weave Panel

Please contact APE for a site specific plan for your playground to ensure CSA compliance and spacing requirements.

*Active Playground Equipment reserves the right to redesign, change or discontinue products without written notice. Products in our printed literature and detailed in our quotations may differ from what is available at the time an order is placed. Please check with your Active Playground representative to confirm that the product you will receive is what you are expecting. Revised January 2019.



Log Table and 4 Chairs



- ADA Accessible
- Available in 18" and 22" heights
- Sealed and treated for water resistance
- 4 log seats included
- Hardwood



A beautiful addition to any play space, the log table is the perfect spot to enjoy a peaceful moment, host a tea-party, or simply rest and catch your breath. Encouraging parallel, joint, or cooperative play, this ADA accessible log table includes four log seats for group activities. Available in infant and toddler heights, the sealed and treated, hardwood table and chairs are water resistant, making them ideal for hosting fancy dinner parties with friends, both real and imaginary.



Motor Skills

- Balance
- Motor Planning
- Crossing the Midline
- Hand-Eye Coordination
- Pincer Grasp



Cognitive

- Problem Solving (Logic & Reasoning)
- Focus
- Attention



Social/Emotional

- Parallel, Joint or Cooperative Play
- Sharing



Communication

- Expressive and Receptive Language
- Role Playing









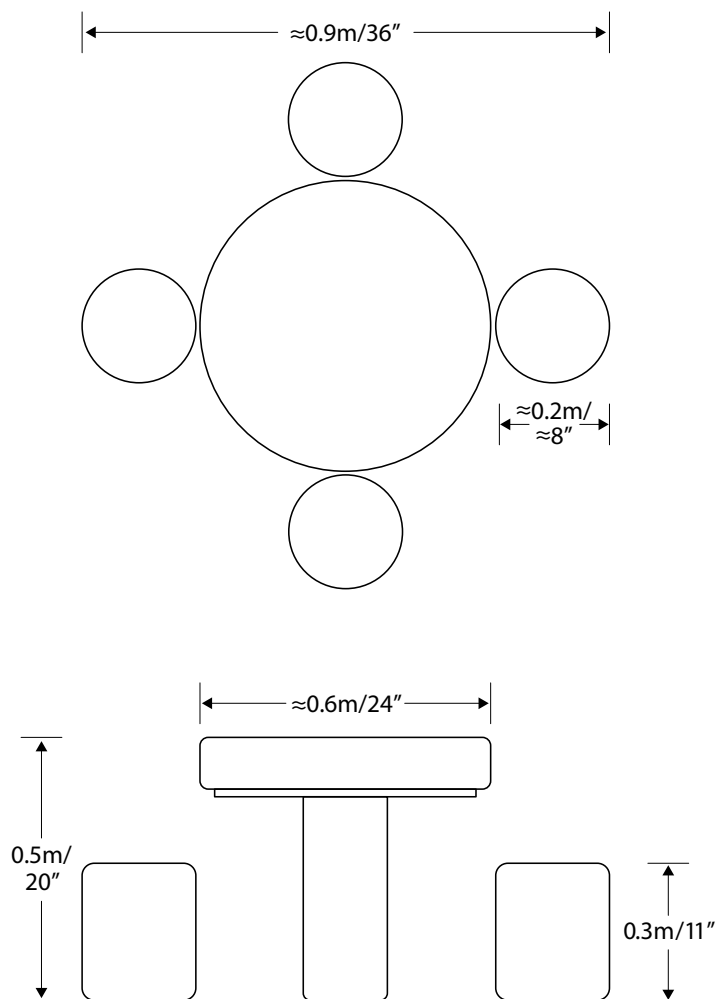

Sensory Processing

- Tactile
- Visual



Log Table and 4 Chairs



-  **Target Age**
18 months to 5 years
-  **Use Area**
6.69 m² / 72 ft²
-  **Installation Type**
Easy
-  **Est. Weight**
350 lb
-  **Safety Surfacing**
Not Required
-  **Dimensions**
0.9m x 0.9m x 0.5m
36" x 36" x 20"
-  **Materials**
 - Raw Lumber
 - Pressure Treated Lumber

Please contact APE for a site specific plan for your playground to ensure CSA compliance and spacing requirements.

*Active Playground Equipment reserves the right to redesign, change or discontinue products without written notice. Products in our printed literature and detailed in our quotations may differ from what is available at the time an order is placed. Please check with your Active Playground representative to confirm that the product you will receive is what you are expecting. Revised January 2019.

